

NOBILI



TBE TBE-S SERIE 102

Trincia professionale specializzata per gli spazi verdi

Specialized professional mulcher for green spaces

Trituradora especializada profesional para los espacios verdes





TBE TBE-S

SERIE 102

Per la trinciatura di spazi verdi, argini e bordi stradali

I Triturator Nobili TBE e TBE-S serie 102 sono attrezzature spostabili di tipo semi-portato, applicabili ai tre punti del sollevatore, ideali per la trinciatura di superfici inerbite e per la manutenzione di bordi stradali, argini, siepi, prati e giardini. Specializzate e robuste, le trince TBE e TBE-S serie 102 appoggiano su un rullo a fondelli smontabili e su slitte arrotondate che ne regolano l'altezza di lavoro. La gamma TBE e TBE-S serie 102 è provvista di un sistema di sicurezza contro gli urti accidentali ed è anche disponibile nella versione sinistra. Le trince TBE e TBE-S dispongono di un'ampia scelta di coltelli intercambiabili, di forme e dimensioni diverse per soddisfare le varie esigenze di lavoro. Il Triturator è costruito in conformità alle Normative Europee.

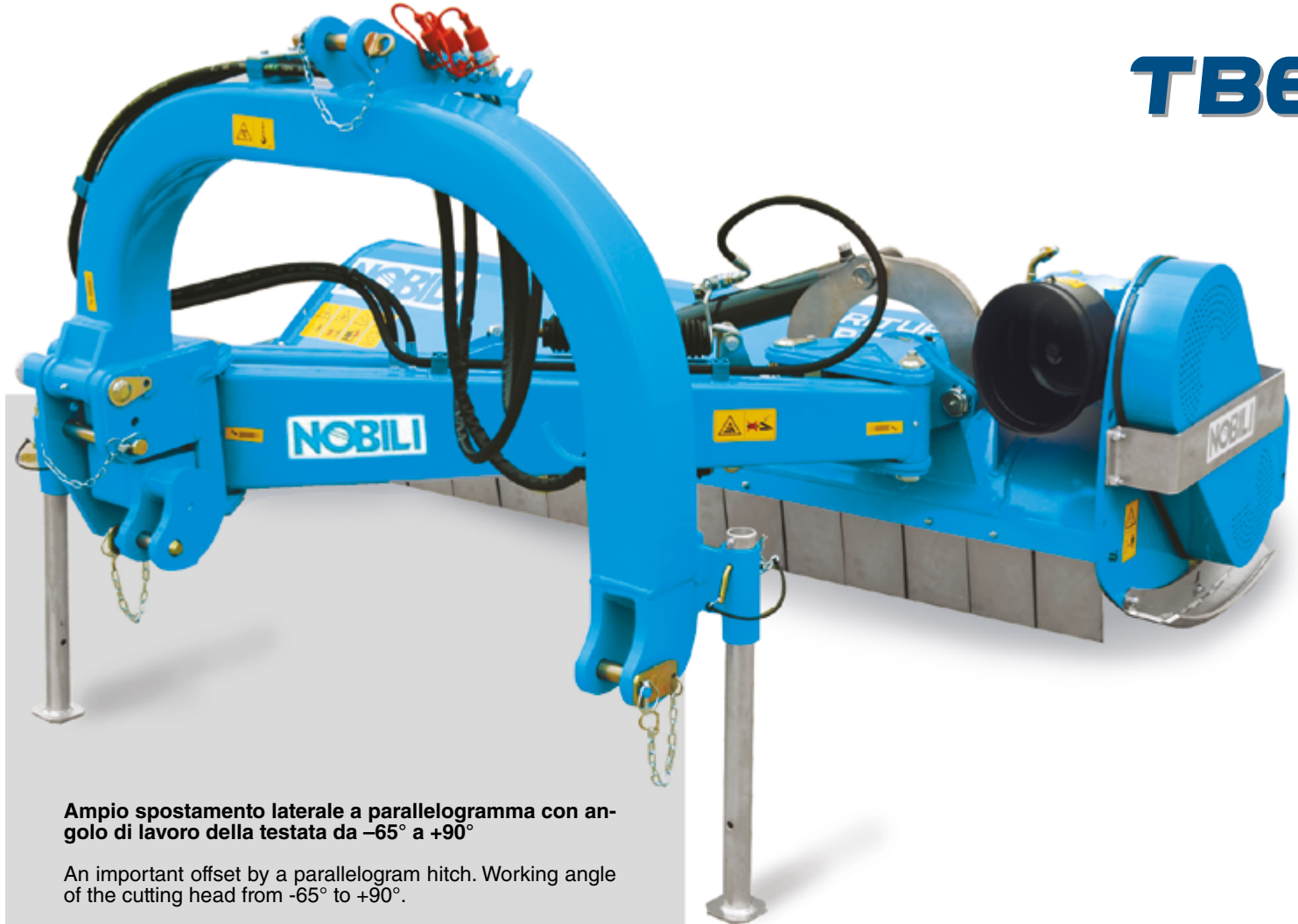

TBE

Ampio spostamento laterale a parallelogramma con angolo di lavoro della testata da -65° a $+90^\circ$

An important offset by a parallelogram hitch. Working angle of the cutting head from -65° to $+90^\circ$.

Un importante desplazamiento lateral por enganche con brazos de paralelogramo. Ángulo de trabajo de la máquina de -65° a $+90^\circ$.



Trinciatura più omogenea in posizione laterale poiché il trattore non calpesta la vegetazione

A more homogenous shredding in offset position because the tractor doesn't ride over vegetation.

Una trituration más homogénea en posición de desplazamiento lateral con el tractor que no pasa sobre la vegetación.

For the shredding of green spaces,
embankments and roadsides

Mulchers Nobili TBE and TBE-S series 102 are tractor mounted offset machines, fitted on the three point tractor linkage. Ideal for shredding grassy areas and for maintenance of roadsides, embankments, hedges, meadows and gardens. Specialized and sturdy, TBE and TBE-S series 102 mulchers are supported by a roller with removable ends and large rounded skids adjusting the working height. TBE and TBE-S series 102 range is provided with a safety system to prevent from accidental shocks and it is also available as left-hand version. A wide choice of interchangeable knives is available with different shapes and dimensions to meet varying working needs. The mulcher is constructed in compliance with European Regulations.

Par la trituration de espaces verts,
taludes y bordes de carreteras

Las Trituradoras Nobili TBE y TBE-S serie 102 son equipos de tipo suspendido en tres puntos para enganche al levantador del tractor, con desplazamiento lateral. Concebidas para la trituration de áreas verdes y para el mantenimiento de bordes de carreteras, taludes, setos, prados y jardines. Especializadas y robustas, las trituradoras TBE y TBE-S serie 102 están provistas de un rodillo de apoyo con componentes desmontables y grandes patines para el control de altura de trabajo. TBE y TBE-S serie 102 es una gama dotada de un sistema de seguridad para evitar los golpes accidentales y también está disponible en la versión izquierda. Una amplia gama de cuchillas intercambiables está disponible con diferentes formas y dimensiones para satisfacer las diversas necesidades de trabajo. La trituradora es fabricada en conformidad con las Directivas Europeas.

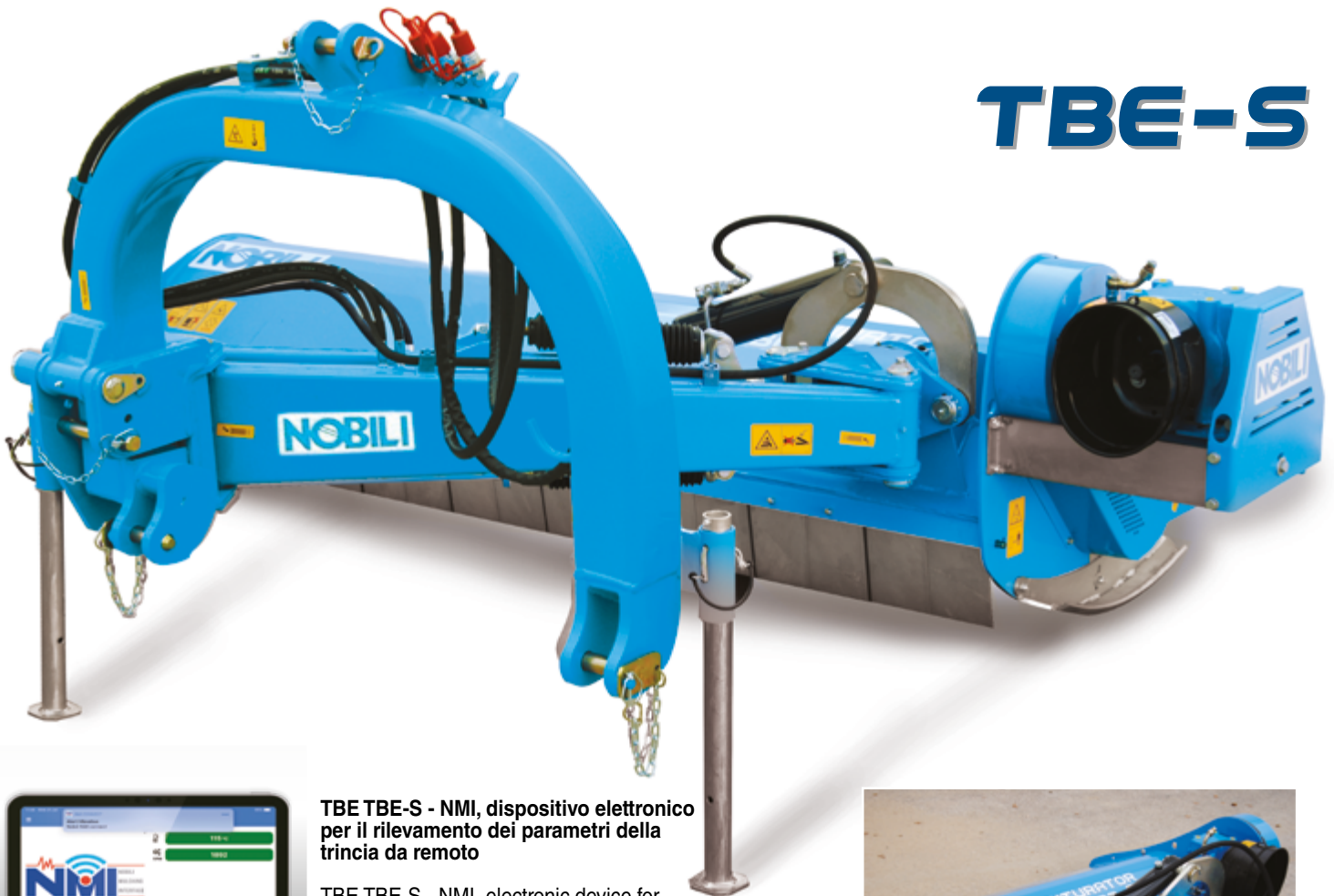

TBE-S



TBE TBE-S - NMI, dispositivo elettronico per il rilevamento dei parametri della trincia da remoto

TBE TBE-S - NMI, electronic device for remotely detecting the mulcher parameters

TBE TBE-S - NMI, dispositivo electrónico para la detección remota de los parámetros de la trituradora



Testata di taglio flottante con cilindro a semplice effetto per seguire gli avvallamenti del terreno

Floating cutting head with single acting cylinder for ground adaptation.

Cajón de trituración flotante con cilindro de simple efecto para adaptación al terreno.

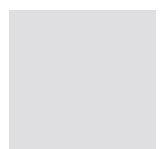

I Trituratori TBE e TBE-S sono progettati per ridurre i tempi e i costi della manutenzione

TBE and TBE-S mulchers have been designed to reduce times and costs of maintenance.

TBE y TBE-S trituradoras han sido diseñado para reducir los tiempos y costos de mantenimiento.



Telaio con doppia cofanatura in acciaio ad alta resistenza.

Chassis with double hood made of high resistance quality steel.

Chasis con capó de doble placa hecho de acero de calidad y alta resistencia.



Braccio sfilabile con sistema di sicurezza contro gli urti accidentali in lavoro.

Telescopic arm with a safety system against accidental shocks during work.

Brazo telescópico con dispositivo de seguridad contra choques accidentales durante el trabajo.

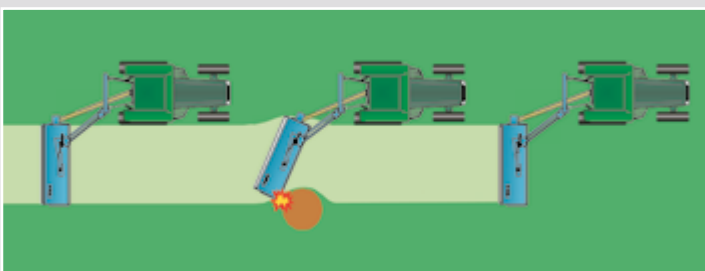

Timone e bracci di sezione elevata. Articolazioni montate su boccole in bronzo e perni bloccati in rotazione.

Headstock and arms of large section. Pivoting points fitted on brass bushes and pins stopped from rotating.

Enganche y brazos de gran sección. Todas las articulaciones están montadas sobre aros de desgaste de bronce y pernos con sistema anti-rotación.

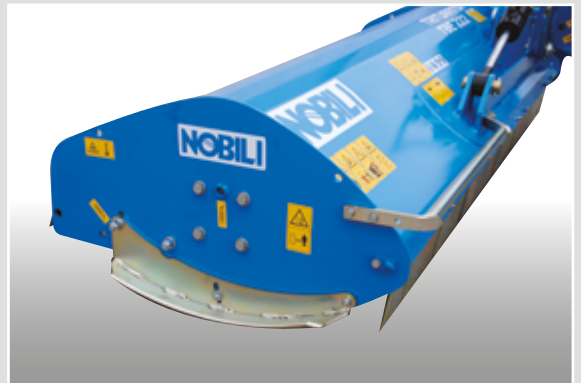

Supporti rotore interni con ingrassaggio sui cuscinetti. Barra di protezione contro gli urti accidentali in lavoro.

Inner rotor supports for bearings with greaser. Protection guard to prevent from accidental shocks at work. *Soportes del rotor internos con rodamientos con engrasador. Barra de protección para evitar los choques accidentales en trabajo.*

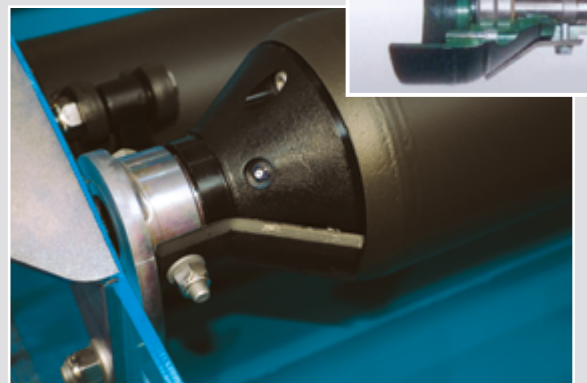

Rullo Ø180 con fondelli smontabili. 4 labirinti con ingrassatore e 2 guarnizioni per proteggere i cuscinetti lubrificati a vita.
Roller of 180 mm diameter with removable ends
4 labyrinths with greaser and 2 seals to protect the life-greased bearings.

Rodillo de 180 mm de diámetro con componentes desmontables 4 laberintos con engrasador y 2 sellos para proteger los rodamientos engrasados por vida.



CARATTERISTICHE - SPECIFICATIONS - CARACTERISTICAS



Gruppo rinvio con ruota libera in posizione interna (TBE) o esterna (TBE-S)

Gearbox with free wheel in inside position (by TBE) or outside (by TBE-S)

Caja de cambios con rueda libre en la posición interior (por TBE) o exterior (por TBE-S)



Doppio controcoltello saldato per una trinciatura fine in ogni condizione.

Welded double counter-knife for an excellent shredding in every condition

Doble contro-cuchilla soldado para una trituración muy fina en cada condición



Rotore a 4 file di utensili che garantisce la costante pulizia del rullo di appoggio.

Rotor with 4 rows of knives providing for the roller constant cleaning of the roller.

Rotor con 4 filas de cuchillas que garantiza la limpieza constante del rodillo de apoyo.

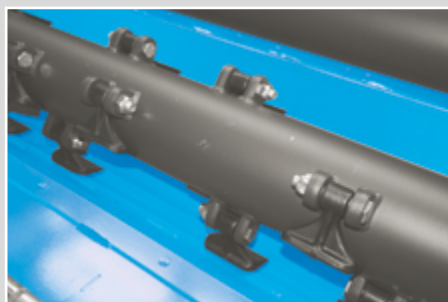

Equilibratura elettronica ai massimi regimi di lavoro della macchina. Coltelli e mazze su perno trattato Ø 20 mm per una minore usura.

Electronic balancing at maximum machine working rates. Knives and hammers on treated axle of diameter 20 mm for reduced wear.

Equilibrio electrónico a la velocidad máxima de trabajo de la máquina. Los cuchillas y martillos en el eje tratado de diámetro 20 mm para reducir el desgaste.



Slitte di consumo arrotondate in hardox per non lasciare solchi sulle aree verdi.

Support rounded skids in hardox to leave no tracks over green areas.

Patines de apoyo redondeadas en hardox para no dejar pistas sobre áreas verdes.

CARATTERISTICHE - SPECIFICATIONS - CARACTERISTICAS

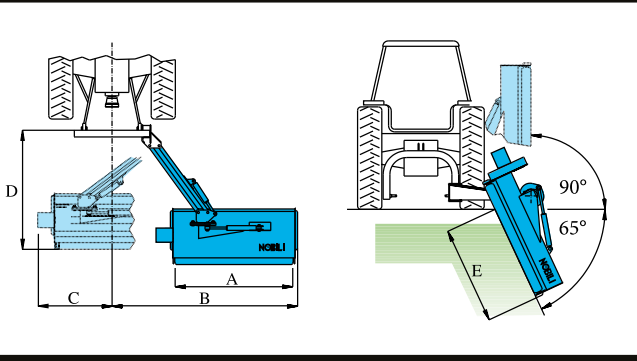

	TBE 192	TBE-S 192	TBE 222	TBE-S 222	TBE 242	TBE-S 242	TBE-S 262
A	1900	1900	2200	2200	2400	2400	2600
B	2806	3024	3158	3376	3244	3445	3728
C	764	545	764	545	827	545	545
D	2175	2175	2175	2175	2175	2175	2175
E	1200	1418	1550	1768	1700	1918	2120

Caratteristiche tecniche Technical specifications Características técnicas		TBE 192 TBE-S 192	TBE 222 TBE-S 222	TBE 242 TBE-S 242	TBE-S 262		
Attacco Linkage Enganche		Categoria 2° -3N Category 2° - 3N Categoría 2° - 3N		Categoria 2° -3N Category 2° - 3N Categoría 2° - 3N			
	Larghezza di lavoro Working width Anchura de trabajo	mm	1792	2144	2295	2496	
	Larghezza massima della testata Overall width of the cutting head Anchura máxima del cajón de trituración	mm	2060 / 2330	2423 / 2694	2572 / 2920	3121	
Numero giri presa di forza PTO transmission speed Frecuencia de rotación t.d.f.		rpm	540	540	540	540	
	Potenza trattrice compresa tra Tractor power requirement ranging from Potencia tractor incluida entre	CV	80-130	90-150	100-170	110-180	
		kW	59-96	66-110	74-125	81-132	
Ruota libera Free wheel Rueda libre		Sul gruppo rinvio - Integrated in gearbox					
Trasmissione del rotore Rotor drive Transmisión rotor		N. 4	Cinghie SPBX Correas SPBX	N. 4	Cinghie SPBX Correas SPBX	N. 4	Cinghie SPBX Correas SPBX
Diametro del rotore Rotor diameter Diámetro rotor		mm	450	450	450	450	
Velocità di rotazione del rotore Rotor speed Velocidad de rotación rotor		rpm	2205	2205	2205	2205	
Velocità lineare dei coltelli Blades linear speed Velocidad lineal de cuchillas		m/s	52	52	52	52	
	Numero di coltelli Number of knives Número de cuchillas	01	40	48	52	56	
		06	20	24	26	26	
Regolazione dell'altezza Height control Control de altura		Slitte, rullo - Skids, roller-patines, Rodillo					
Peso Weight Peso	TBE	kg	925	980	1030	1030	
	TBE-S	kg	960	1015	1065	1100	



01
Universale: legna, erba.
Universal: wood, grass.
Universal: leña, hierba



06
Mazza: legna, erba.
Hammer: wood, grass.
Martillo cuchara: leña, hierba

Concessionario / Dealer / Distribudor



40062 MOLINELLA (Bologna) - Italy - Tel. +39 051 881444
www.nobili.com - info@nobili.com

Per rispetto dell'ambiente, questo documento è stampato su carta senza cloro. In respect for the environment, this document is printed on chlorine-free paper. Para respetar el medio ambiente, este documento ha sido impreso sobre papel sin cloro. Las características de los modelos se ofrecen a mero título indicativo. Le caratteristiche dei modelli sono date a puro titolo indicativo. La NOBILI S.p.A. si riserva il diritto di modificarle in qualsiasi momento, senza alcun preavviso. - Specifications subject to change without notice. S.p.A. se reserva el derecho de modificarlas en cualquier momento, sin preaviso alguno.